

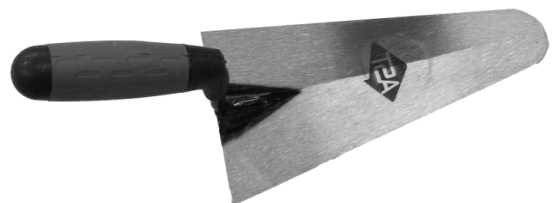

# Ferramenta Universal

“A”

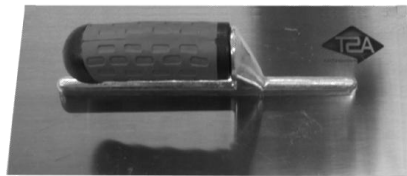

## Martelo Carpinteiro

Ref	Descrição
STHT0-51309	450gr
STHT0-51310	570gr



## Martelo Cofrador

Ref	Descrição
STHT0-54123	750gr



## Martelo Cofrador Unha

Ref	Descrição
STHT0-51311	600gr



## Martelo Campo

Ref	Descrição
STHT0-54126	800gr
STHT0-54127	1250gr



## Maço em Plástico

Ref	Descrição
1-57-053	320gr



## Alicate Grip Boca Curva

Ref	Descrição
0-84-808	185mm
0-84-809	225mm



## Alicate Grip "C"

Ref	Descrição
0-84-815	170mm
0-84-816	185mm



## Alicate C/Diagonal

Ref	Descrição
FMHT0-70814	200mm



## Alicate C/Diagonal

Ref	Descrição
STHT0-74455	180mm



## Alicate Desnudar Fio

Ref	Descrição
STHT0-75068	150mm



## Mini Alicate Corte Diagonal

Ref	Descrição
FMHT080518	150mm



## Tesoura Corte à Direita

Ref	Descrição
2-14-564	250mm



## Tesoura Corte Reto

Ref	Descrição
2-14-563	250mm



## Tesoura Corte à Esquerda

Ref	Descrição
2-14-562	250mm



## Tesoura Corte longo

Ref	Descrição
2-14-566	300mm



## Turquesa Cimenteiro

Ref	Descrição
2-84-179	200mm
2-84-302	220mm



## Turquesa Cimenteiro Fatmax

Ref	Descrição
4-95-100	300mm



## Alicate de Rebitar

Ref	Descrição
6-MR55	Rebites 5mm



## Alicate Extensivel

Ref	Descrição
0-84-648	254mm



## Tesoura Perfilagem *DEWALT*

Ref	Descrição
DWHT-14687-0	3 laminas



## Pistola Cola

Ref	Descrição
6-GR15 Mini	



## Pistola Cola

Ref	Descrição
FMHT6-70418	100W a 200W



## Formões Cabo Plástico

Ref	Descrição
0-16-871	8mm
0-16-872	10mm
0-16-873	12mm
0-16-874	14mm
0-16-875	15mm
0-16-876	16mm
0-16-877	18mm
0-16-878	20mm
0-16-879	22mm
0-16-880	25mm
0-16-890	30mm



## Jogo de Formões

Ref	Descrição
2-16-888	6;10;15;20;25mm



## Trono de Bancada

Ref	Descrição
1-83-066	100mm
1-83-067	125mm
1-83-068	150mm



## Serrote Carpinteiro

Ref	Descrição
STHT20369-1	380mm
STHT20370-1	450mm
STHT20371-1	500mm
STHT20372-1	550mm



## Serrote Sharp Cut (dente fino)

Ref	Descrição
STHT20367-1	500mm



## Serrote Tradecut

Ref	Descrição
STHT20355	450mm
STHT20351	500mm
STHT20353	550mm



## Serrote Gen2

Ref	Descrição
2-20-528	450mm
2-20-528	500mm
2-20-530	550mm



## Serrote Jet Cut (Placas de gesso)

Ref	Descrição
2-20-037	550mm



## Serrote Jet Cut *FINE*

Ref	Descrição
2-15-594	380mm
2-15-595	450mm
2-15-599	500mm
2-15-244	550mm



## Serrote Jet Cut *SP*

Ref	Descrição
2-15-288	500mm
2-15-289	550mm



## Serrote P/Paneis (pladur)

Ref	Descrição
0-15-206	152mm



## Serrote Corte Ferro

Ref	Descrição
1-15-122	300mm

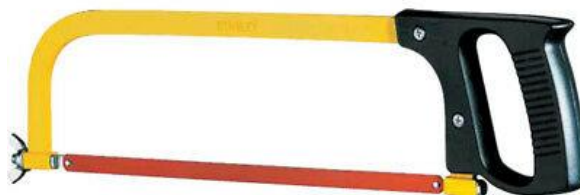

## Serra p/Metals Fatmax

Ref	Descrição
0-20-108	300mm



## Serrote Costas

Ref	Descrição
2-17-199	300mm



## Serrote c/ Esquadria

Ref	Descrição
1-20-600	300 x 130



## Folha de Serra Ruby

Ref	Descrição
1-15-906	300mm



## Grosa Plana

Ref	Descrição
0-22-465	Bastarda – 200mm
0-22-467	Meio Murço – 200mm



## Laminas para Raspador

Ref	Descrição
0-28-292	64mm



## Plaina Metálica

Ref	Descrição
1-12-004	250x50mm



## Plaina Metálica

Ref	Descrição
1-12-033	210x45mm



## Plaina Curta de Plástico

Ref	Descrição
5-21-104	155mmx x140mm



## Plaina Standard Metal

Ref	Descrição
2-21-296	310mm



## Lima Metal

Ref	Descrição
2-21-295	440mm



## Lamina Surform c/Fino

Ref	Descrição
5-21-398	140mm x 42mm

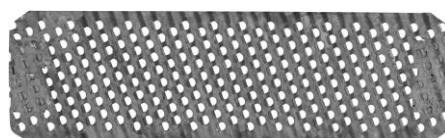

## Kit Afiador (guia + pedra de afiar + óleo)

Ref	Descrição
0-16-050	Pedra Grão 400 e 600



## Jogo Cinzeis Pedreiro

Ref	Descrição
4-18-298	3 peças



## Suta de Carpinteiro

Ref	Descrição
0-46-825	267mm



## Esquadro Carpinteiro

Ref	Descrição
1-45-685	140x250
1-45-686	200x300
1-45-687	200x400

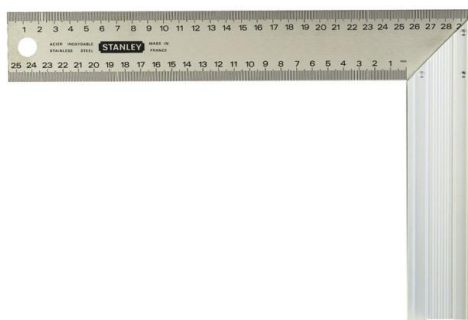

## Lanterna Frontal

Ref	Descrição
FMHT81509-0	LED; Sensor Movimento;





## JOGO DE PONTAS 1/4" - 25MM - 31pcs

Ref	Descrição
1-13-903	Fenda: 4, 4.5, 5.5 mm Philips: PH1, PH2, PH3 Pozidrive: PZ1 -PZ2 - PZ3 Torx: T10 - T15 - 2xT20 - 2xT25 - T30 - T40 Torx Inviolável: : T10 - T15 - T20 - T25 - T30 Hexagonal: 3, 4, 5, 6mm Portapontas 60 mm - adaptador



## JOGO DE PONTAS 1/4" - 25MM - 19pcs

Ref	Descrição
1-13-901	Fenda: 4.5, 5.5, 6.5 mm Philips: PH1, PH2 Pozidrive: PZ1 -PZ2 - PZ3 Torx: T10 - T15 - T20 - T25 - T30 - T40 Hexagonal: 3, 4, 5, 6mm Portapontas 60 mm



## Pont. (Bits) PH

Ref	Descrição
3-68-942	1 x 25mm



## Multipontas de Roquete

Ref	Descrição
FMHTO-62691	12 Pontas



## Jogo Chaves Hexag. 8pcs

Ref	Descrição
0-97-552	1,5; 2; 2,5; 3; 4; 5; 6; 8



## Jogo Chaves Precisão

Ref	Descrição
0-66-052	Jg 6 chaves

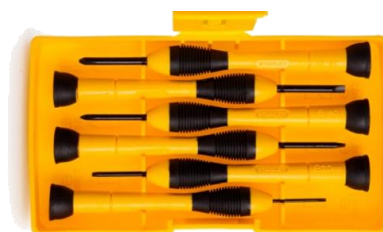

## Facas de Alcatifa

Ref	Descrição
0-10-150	9x130mm
0-10-151	18x160mm



## Facas de Alcatifa

Ref	Descrição
0-10-425	25x180mm



## Facas de Alcatifa

Ref	Descrição
0-10-486	25x215mm



## Facas de Alcatifa

Ref	Descrição
0-10-018	18x165mm

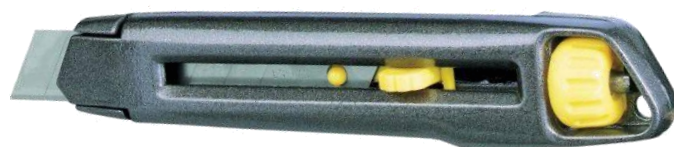

## Facas de Alcatifa

Ref	Descrição
FMHT10329-0	18mm



## Facas de Alcatifa

Ref	Descrição
STHT110268-1	18x165



## Facas de Alcatifa

Ref	Descrição
0-10-481	18x165mm



## Facas de Alcatifa

Ref	Descrição
1-10-099	155



## Facas de Alcatifa

Ref	Descrição
0-10-788	180mm



## Facas de Alcatifa

Ref	Descrição
0-10-778	170mm



## Facas de Alcatifa

Ref	Descrição
0-10-088	150mm



## Laminas F/Alcatifa

Ref	Descrição
0-11-301	18mm



## Laminas F/Alcatifa

Ref	Descrição
1-11-916	Cx 100 uni



## Laminas F/Alcatifa

Ref	Descrição
1-11-802	50mm x 19xx



## Laminas F/Alcatifa

Ref	Descrição
1-11-983	50mm x 19mm



## Agrafador

Ref	Descrição
6-TR45	A 6 - 8 - 10

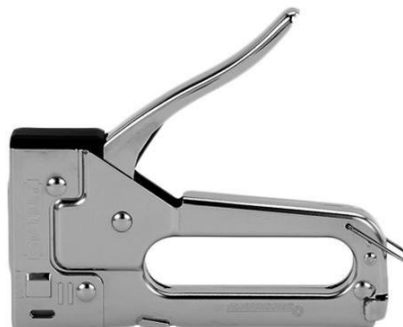

## Agrafador

Ref	Descrição
6-TR150L	A 6-8 -10-12-14



## Agrafador

Ref	Pregos	Agrafes
FMHT6-70868	15 (J) – 15(9)	6-14(A); 6-14 (H); 6-14 (G); 12-17 (7)



## Agrafador

Ref	Descrição
FMHT0-80551	Pulsador dianteiro



## Agrafes

Ref	Descrição
1-TRA204T	6mm
1-TRA205T	8mm
1-TRA206T	10mm
1-TRA208T	12mm



## Lixadora Manual

Ref	Descrição
STHT0-05927	230x80



## Lixadora Manual c/ cabo

Ref	Descrição
STHT0-05928	1,30M



## Desempenadeira Esquinas Red.

Ref	Descrição
STHTO – 05898	280 x 130
STHTO – 05899	320 x 130



## Espátulas

Ref	Descrição
STHTO – 05786	100mm
STHTO – 05864	152mm



## Espátula c/Ponta Philips

Ref	Descrição
STHTO – 28041	PH2; 150mm



## Nível Stanley Classic

Ref	Descrição
STHT1-43102	40cm
STHT1-43103	60cm
STHT1-43104	80cm
STHT1-43105	100cm
STHT1-43106	120cm
STHT1-43107	150cm
STHT1-43109	200cm



## Nível Trapezoidal Fatmax

Ref	Descrição
1-42-312	40cm
1-42-313	50cm
1-42-314	60cm
1-42-315	80cm
1-42-316	100cm



## Nível Fatmax 2 Bases

Ref	Descrição
1-42-252	50cm
1-42-253	60cm
1-42-254	80cm



## Nível Perfilado 180°

Ref	Descrição
1-42-920	60cm



## Nível Torpedo Alto Impacto

Ref	Descrição
0-43-511	23cm



## Nível Torpedo Plastico

Ref	Descrição
0-42-294	20cm



## Nível e Medidor Ângulos Digital

Ref	Descrição
0-42-087	40cm



## Metro Dobrável Fibra Vidro

Ref	Descrição
0-35-229	2M

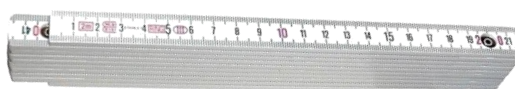

## Topómetro Fatmax MW-40m

Ref	Diam da Roda
1-77-175	318mm



## Fita Métrica TYLON

Ref	Descrição
1-30-687	3x13
1-30-697	5x19
1-30-657	8x25



## Fita Métrica Powerlock

Ref	Descrição
0-33-194	5M x 19mm
0-33-198	8M x 25mm
0-33-442	10M x 25mm



## Fita Métrica Fibra Vidro

Ref	Descrição
0-34-295	10x12,7
0-34-296	20x12x7
0-34-297	30x12,7



## Fita Métrica Fibra Vidro

Ref	Descrição
2-34-772	30x12,7
2-34-775	60x12,7



## Marcador Recta

Ref	Descrição
0-47-465	30M



## Marcador Recta KIT

Ref	Descrição
0-47-443	30M



## Marcador Recta Alumínio

Ref	Descrição
0-47-100	30M



## Mini Marcadores

Ref	Descrição
1-47-329	Marcador mini ponta fina cor negro, vermelho, azul, verde - caixa 72 uds



## Marcadores

Ref	Descrição
0-47-314	Marcador ponta larga cor negro,



## Marcadores

Ref	Descrição
0-47-316	Marcador ponta fina cor negro,



## Malas de Ferramenta

Ref	Descrição
STST82976-1	66,5 x 33,5 x 28,0
STS1-75521	48,2 x 25,4 x 25
STS1-75518	40,6 x 20,5 x 19,5
STS1-75515	32 x 18,8 x 13,2



### Trolley 3 em 1

Ref	Descrição
STST1- 80151	Oficina Móvel

### Organizer

Ref	Descrição
1-92-748	42,2 x 5,2 x 33,4
1-92-749	42,3 x 10,5 x 33,4



### Organizer

Ref	Descrição
1-94-745	43 x 9 x 33
1-97-483	37,5 x 6,7 x 29,2



### Bolsa

Ref	Descrição
1-96-181	23,5 x 33,2 x 7,5
1-96-179	24 x 15,5 x 6



## BELLOTA



REF.			g	A mm	B mm	C mm
4539-18	424775	12	560	457	186	20
4539-21	314458	12	600	533	209	20
4539-24	314465	12	730	610	239	20
4539-30	314472	12	850	762	249	20



REF.			g	A mm	B mm	C mm
4540-18	424812	12	560	457	186	20
4540-21	314489	12	600	533	209	20
4540-24	314496	12	730	610	239	20
4540-30	314502	12	850	762	249	20

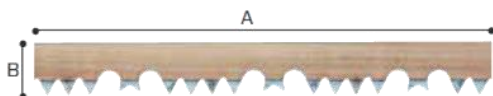

REF.			g	A mm	B mm
4535-18	424683	12	40	457	20
4535-21	314397	12	46	533	20
4535-24	314403	12	56	610	20
4535-30	314410	12	71	762	20



REF.			g	A mm	B mm
4537-21	314427	12	46	533	20
4537-24	314434	12	56	610	20
4537-30	314441	12	71	762	20



REF.			g	A mm	B mm
4630-12	404883	6	560	400	104

# BELLOTA

REF.			g	A mm	B mm
8130-500	156515	6	500	400	95
8130-600	156522	6	600	420	100
8130-700	156539	6	700	450	105
8130-800	156546	6	800	450	110
8130-2000	156584	6	2.000	800	155

REF.			g	Amm	Bmm	Cmm	M
5932-00 N	631852	6	300	300	205	38	M 8031-ON

REF.			g	Amm	Bmm	Cmm	M
8002-13	363708	6	350	300	118	27	M 8002-13
8002-16	611915	6	450	315	130	28	M 8002-16
8002-20	611939	6	540	330	135	30	M 8002-20
8002-24	611953	6	660	345	147	33	M 8002-24

REF.			g	Amm	Bmm	Cmm	M
8009-D	140804	6	700	349	124	34	M 8011-E

REF.			g	Amm	Bmm	Cmm	M
8017-B	143102	6	400	450	140	26	M 8017-B
8017-C	143201	6	500	450	148	28	M 8017-C

REF.			g	A mm	B mm	C mm
8006 CF	625370	6	570	325	170	26



# BELLOSTA



REF.	8 41 4299		g	A mm	B mm
5876	134032	12	110	180	121

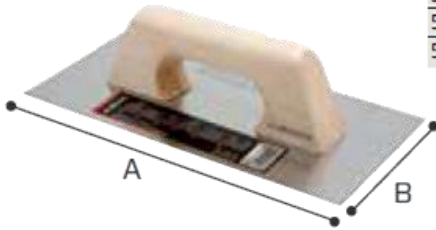

REF.	8 41 4299		g	A mm	B mm
5877-03	134605	12	110	180	121
5877-06	134780	12	110	180	121
5877-08	134865	12	110	180	121

REF.	8 41 4299		g	A mm	B mm
5861-1	133905	6	400	300	150



REF.	8 41 4299		g	A mm	B mm
5861-1 INOX	663037	6	400	300	150



REF.	8 41 4299		g	A mm	B mm
5861-00 BIM	547160	6	320	270	135
5861-0 BIM	547184	6	320	300	120
5861-1 BIM	547207	6	375	300	150
5861-2 BIM	547221	6	390	300	160
5861-3 BIM	547245	6	425	300	180



REF.	8 41 4299		g	A mm	B mm
5888	135138	6	255	280	160

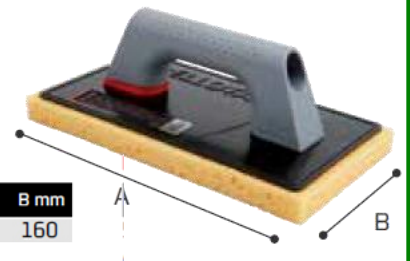

REF.	€	8 41 4299		g	A mm	B mm
5889 A			6	470	254	97
5889 B			6	470	254	97

# BELLOSTA



REF.			g	A mm	B mm
5842-J	132403	6	305	215	116
5842-K	155228	6	325	227	122
5842-L	132601	6	345	240	128



REF.			g	A mm	B mm
5851-B	133400	6	330	215	110
5851-C	133509	6	370	230	115
5851-D	133608	6	400	240	120



REF.			g	A mm	B mm
5850-B	133370	6	350	240	110

REF.			g	A mm	B mm	C mm
5800-3	631081	1	1800	560	290	285

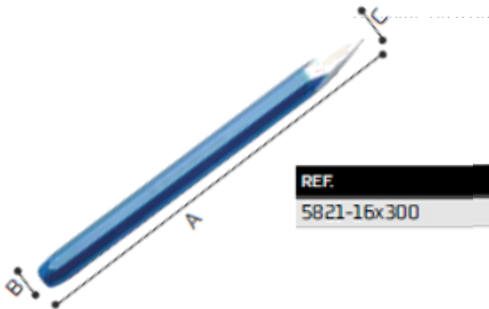

REF.			g	A mm	B mm
5821-16x300	128307	6	470	300	16

REF.			g	A mm	B mm	C mm
5825-16x200	129908	6	300	200	14	23
5825-16x250	130003	6	380	250	16	23



REF.			g	A mm	B mm	C mm
5825-16x300 CP	038521	6	640	300	16	23

REF.			g	A mm	B mm
8280-200	037364	6	220	200	120

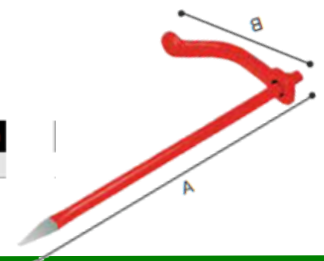

# BELLOTA



REF.			g	A mm	B mm
6001-225	157604	6	330	225	30



REF.			g	A mm	B mm	C mm	D mm	L mm
6162-250 PVC	445442	6	290	34	37	8	33	245



REF.			g	A mm	B mm	L mm
6440-6x7	449266	6	45	10	11	105
6440-8x9	449310	6	58	13	14	110
6440-10x11	449358	6	86	15	16	120
6440-12x13	449396	6	145	18	19	140
6440-14x15	449433	6	140	20	22	145
6440-16x17	449471	6	200	23	24	155
6440-18x19	449518	6	240	25	26	165
6440-20x22	449556	6	300	28	30	170
6440-21x23	449594	6	340	29	31	185
6440-24x26	449693	6	400	33	35	190
6440-25x28	449730	6	500	34	37	205
6440-30x32	449815	6	710	40	42	210



REF.			g	A mm	B mm	C mm
6170	340778	6	710	78	65	250



REF.			g	A mm	B mm	C mm
6902-500	057157	1	5.500	500	200	230

# BELLOSTA

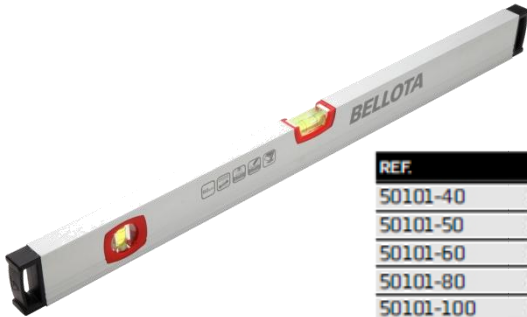

REF.			g	A mm	B mm
50101-40	600353	5	235	400	50
50101-50	600360	5	295	500	50
50101-60	600377	5	350	600	50
50101-80	600384	5	470	800	50
50101-100	600391	5	585	1.000	50



REF.			g	A mm	B mm
50102-50	600414	5	440	500	42
50102-60	600421	5	495	600	42
50102-80	600438	5	770	800	42



REF.			g	A m	B mm
50011-3	618204	24	120	3	16
50011-5	618228	18	200	5	19
50011-8	618242	12	400	8	25



REF.			g	A mm	B mm	M
4050-8x4,0 BS	612059	6	28	200	3,98	M4093-B4
4050-8x4,8 BS	612097	6	33	200	4,76	M4093-B4



REF.			g	A mm	B mm	ml
50262	342239	12	740	350	56	300

# BELLOTA



REF.			g	A mm	B mm	M
5502-3 MA	501407	6	2.235	1.030	335	265



REF.			g	A mm	B mm	M
5501-3 MA	500509	6	2.085	1.040	335	290



REF.			g	A mm	B mm	M
5001-B	120103	6	2.500	480	52	M6

REF.			g	A mm	B mm	+
50320-230	139679	25	170	230	22,2	1,9 AS46 INOX-BF



REF.			g	A mm	B mm	+
50400-115	556506	25	25	115	22,2	1 AS60 INOX-BF
50400-125	586848	25	35	125	22,2	1 AS60 INOX-BF



REF.			g	A mm	B mm	+
50480-115	446999	25	68	115	22,2	3 A24R-BF
50480-125	512656	25	80	125	22,2	3 A24R-BF
50480-180	512564	25	165	180	22,2	3 A24R-BF
50480-230	447057	25	282	230	22,2	3 A24R-BF



REF.			MBox	A mm	B mm	C mm	D mm	Nº
50711-115	405453	1	4	115	22,2	7	2,2	8
50711-230	405545	1	4	230	22,2	7	2,4	16

REF.			MBox	A mm	B mm	C mm	D mm
50712-115	405576	1	4	115	22,2	7	2
50712-230	405675	1	4	230	22,2	7	2,5



# BELLOSTA



REF.			Box	Pallet	Kg		Kg	A mm	B mm	C mm
PRO 65	X		622041	1	11	11,9	15,8	915	330	110

REF.			Box	Pallet	Kg		Kg	A mm	B mm	C mm
PRO 55	X		622034	1	11	10,8	14,9	775	330	110



REF.			Box	Pallet	Kg		Kg	A mm	B mm	C mm
POP 50-R-B	-		621983	6	48	4,2	4,5	700	180	105
POP 50-R-C	X		622003	4	24	4,2	5,8	700	180	105
POP 60-R-B	-		622010	6	48	4,6	4,9	800	180	105
POP 60-R-C	X		622027	4	24	4,6	6,8	800	180	105

REF.			Box	Pallet	Kg		Kg	A mm	B mm	C mm
POP 50-B	-		621969	6	48	4,1	4,4	700	180	105
POP 50-C	X		621976	4	24	4,1	5,7	700	180	105
POP 60-B	-		622355	6	48	4,5	4,8	800	180	105
POP 60-C	X		621990	4	24	4,5	6,7	800	180	105



# GRACILMOR

**Alicate de Vazador**  
**Ref.17020**



**Chave Crescente EXTRA**  
**Ref. AST**  
**Medidas: 8-10-12-15"**



**Chave Crescente**  
**Ref. WG**  
**Medidas: 8-10-12"**



**Chave Bico Papagaio**  
**Ref. WG**  
**Medidas: 9" ; 10,5" ; 12" ; 14"**



**Tesoura Latoeiro**  
**Medidas: 8-10-12"**



**Chaves Bocas**  
Ref. 141-47



**Medidas:**  
6x7 – 30x32  
8 Pcs (6x7 – 20x32)  
12 Pcs (6x7 – 30x32)

**Chaves Luneta**  
Ref. 142-57



**Medidas:**  
6x7 – 30x32  
8 Pcs (6x7 – 20x32)  
12 Pcs (6x7 – 30x32)

**Chaves Boca/Luneta**  
Ref. 143-63



**Medidas:**  
6 – 32  
8 Pcs (6 - 19)  
12 Pcs (6 - 22)  
25 Pcs (6 – 32)

**Chaves Tubulares**  
Ref. 138-98



**Medidas:**  
6x7 – 30x32  
8 Pcs (6x7 – 20x32)



**Chaves Umbraco  
AST 10Pcs  
(1,5 – 10mm)**



**Chaves Umbraco  
Tipo Navalha  
( 1,5 – 8mm)**



**Chaves Umbraco  
2 – 12mm**



**Chaves Umbraco  
11 Pcs (2 – 12mm)**



**Maço Borracha c/ Metálico  
- 250mm**



**Maço Borracha c/Madeira  
- Nº1; Nº2; Nº**



**Martelo Mesa Nylon  
30mm**



**Jogo de Vazadores**  
Ref. 10266 (2,5 – 10mm)



**Paquímetro plástico**  
Ref. 68705

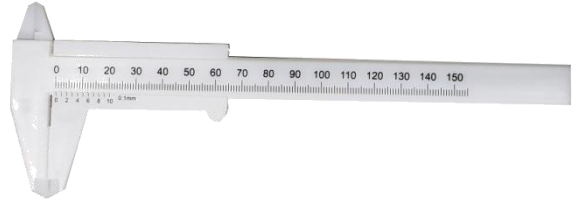

**Paquímetro Inox**  
Ref. 501 AST  
150mm; 200mm



**Paquímetro Inox**  
Ref. 504 AST  
150mm; 200mm



**Alicate de Massa**  
Ref. 13284 – 400Amp



**Porta Eletrodos - WG**  
300 e 500W





# GRACILMOR

## RAMADA

**Serrote Folha Larga**  
**"Caravela"**  
450; 500; 550; 600mm



**Serrote Folha Larga**  
**120 EX**  
450; 500; 550; 600mm



**Serrote Folha Larga**  
**"Rapid"**  
450; 500; 550; 600mm



**Serrote Folha Larga**  
**110 ST**  
450; 500; 550; 600mm



**Serrote Costas**  
**310 ST**  
300; 350mm



**Serrote Costas**  
**310 EX**  
300; 350mm





# GRACILMOR

## RAMADA

**Serrote Ponta**  
**520 ST**  
**300; 350mm**



**Serrote Ponta**  
**520 EX**  
**300; 350mm**



**Serrote Cabo Redondo**  
**330 ST**  
**250; 300mm**



**Serrote de Talho**  
**14020**  
**450; 500; 550mm**



**Betumadeiras Auto**  
**6005**  
**Jogo**



**Raspadores Marceneiro**  
**14020**  
**100x70; 120x70; 140x70**





Serrote de Costas c/ Esquadria  
AST - 300mm



Serrote de Costas AST  
Ref. 7061 - 300mm ; 350mm



Serrote de Carpinteiro ALYCO  
Ref. 1440 (400mm ; 450mm; 500mm)



Serrote de Trabalhos Manuais  
Ref. APM (Nº1 e Nº4)



Arco de Serra Lenhador  
Medidas: 53; 61; 76; 91cm





**Escopro Afiável Ref. 21210 – 16x300**

**Ponteiro Afiável Ref. 21110 – 16x300**



**Escopro Ref. 21420 – 16x300**

**Ponteiro Ref. 21320 – 16x300**



**Grampo de Cofragem**

**80x80**



**Chave de Virar Ferro**

**Ref. 37800 – 6x8**

**Ref. 37810 – 8x10**

**Ref. 37820 – 10x12**

**Ref. 37830 – 12x14**

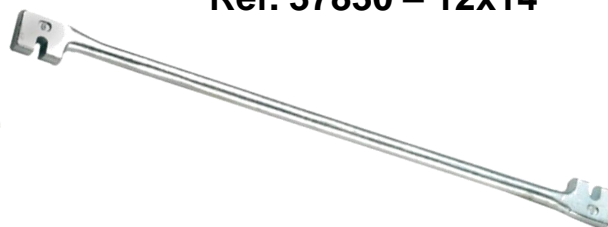

**Cavilhas de Cimenteiro**

**Bellota - 250mm**

**8281 – Quadrada**

**8280 - Redonda**



**Cavilhas de Cimenteiro**

**M129 – Red / Qua**

**250mm**

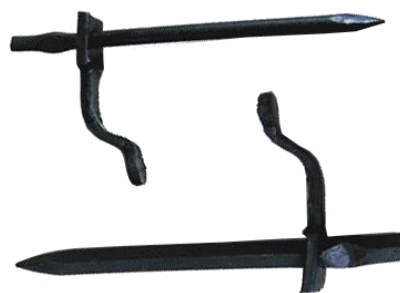



**Jogo Chaves Relojoeiro**  
**Ref. 777 AST**  
**1,0 – 3,5**



**Puas 3 Bicos B. Electrico**  
**SH555 AST**  
**10 – 25mm**



**Chave p/ Berbequim**  
**13mm**  
**Ref. V-20155**



**Adaptador Magnético**  
**SH500 AST**  
**1/4"**



**Bucha p/Berbequim**  
**Ref. 517 AST**  
**10mm; 13mm**



**Bucha p/Berbequim**  
**Automática**  
**Ref. PB 1921**  
**1,5 – 13mm**



**Adaptador SDS**  
**Ref. 6 ASDS**





# GRACILMOR

**Lápis Escolar  
Carvão  
ref. 2005 Viarco**



**Lápis Carpinteiro  
Olimpico Bicolor  
ref. 289 Viarco**



**Lápis Carpinteiro  
Rectangular 18cm  
ref. 1019 Viarco**



**Lápis Carpinteiro  
Olimpico Bicolor  
ref. 293 Viarco**



**Lápis Cópia Violeta  
ref. 272 Viarco  
Médio / Duro**



**Lápis Pastel  
Ref. 107 Viarco**



**Giz Branco  
Anti - Alérgico**



**Lápis Carpinteiro  
Bicolor - Alyco  
ref. 149055 -175mm**





# GRACILMOR

**Formões cabo madeira**  
**Plasan**  
**4 a 40mm**



**Bedames cabo madeira**  
**Plasan**  
**2 a 10mm**



**Goivas cabo madeira**  
**Plasan**  
**6 a 20mm**



**Ferros Betumar e Tornígio**  
**Lobo**



**Enchós cabo madeira**  
**0 - 1 - 2**



**Ferros Rústicos**  
**Lobo**  
**10-15-20-25-30mm**



**Travadeira Automática**  
**Ref. 10812**  
**180mm**

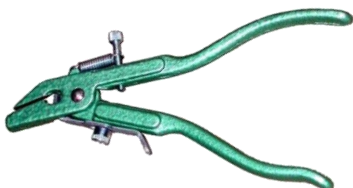

**Verrumas cabo Torcido**



## ALYCO



**Alicate Pontas**  
**Ref. 9510**  
**VDE- 200 (1000V)**



**Alicate Pontas Chatas**  
**Ref. 9520**  
**VDE- 160 (1000V)**



**Tirquesa Cimenteiro**  
**Reforçada**  
**Ref. 11410 – 300mm**



**Tirquesa Cimenteiro**  
**Ref. 11405 – 225mm**



**Chave Crescente**  
**Ref. 172254 – 15"**  
**Ref. 172255 – 18"**  
**Ref. 172256 – 24"**

## ALYCO



**Chave Roquete 1/2"**  
**Ref. 170720**



**Chave Roquete 3/8"**  
**Ref. 170710**



**Chave Roquete 1/4"**  
**Ref. 170700**



**Chaves Caixa 1/2 "**  
**Ref. 192300 (10 – 32)**



**Formões Cabo Plástico**  
**(6 – 38mm)**  
**Ref. 12500**



**Serrote Pontas**  
**Ref. 144098**

## ALYCO



**Chave de Tubo c/corrente**  
Ref. 111340 – 500mm  
Ref. 111342 – 450mm



**Chave de Tubo c/corrente**  
Ref. 111344 – 900mm



**Chave de Pontas Flexível**  
Ref. 119102  
1/4" – 190mm



**Pá Alumínio Quadrada**  
Ref. 168617  
(245x300mm)



**Jogo Punções**  
6 pcs  
Ref. 140019

## ALYCO



**Marcador de Recta  
+  
Pó  
Ref. 196195**



**Pistola Inyectar Profi.  
Ref. 198810**



**Pistola Inyectar Profi.  
Ref. 198807**



**Pistola p/espuma Profi.  
Ref. 198820**

## ALYCO



**Maceta C/ Madeira**  
**Ref. 196503 – 1,0Kg**



**Compasso Aço Pontas**  
**Ref.149002 – 150mm**  
**Ref.149003 – 200mm**  
**Ref.149004 – 250mm**



**Taloça Plástica**  
**Rect.**  
**Cabo Madeira**  
**Ref. 195790 (270x180)**



**Taloça Plástica**  
**Bico**  
**Cabo Madeira**  
**Ref. 195792 (270x180)**

## ALYCO



**Bolsa de Ferramenta  
Ref. 196895**



**Bolsa de Ferramenta c/cinto  
Ref. 196894**



**Bolsa de Ferramenta  
Ref. 196870**



**Porta Martelo  
Ref. 196896**



**Cinto de Couro p/Bolsa  
Ref. 196885**



**Lanterna 27 Leds**  
**Ref.190511**



**Lanterna Bifocal**  
**27 Leds**  
**Ref.190540**



**Lanterna 9 Leds**  
**Ref.170955**



**Lanterna de Bolso**  
**Leds**  
**Ref.190544**

**Organizador de Consumíveis**  
**Ref. 192762**  
**(420x335x62)**



**Organizador de Consumíveis**  
**Ref. 192760**  
**(210x338x62)**



**Fita Métrica**  
**Ref. 197310**  
**(5Mt x 25mm)**  
**(Cx 12 unidade)**



**Angulos Magnéticos**  
**Ref. 197992 - 100mm**  
**Ref. 197995 - 120mm**  
**Ref. 197996 - 150mm**

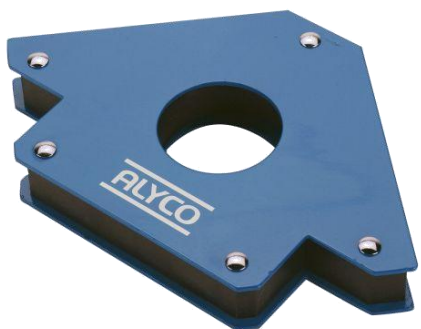



Accesorios  
No incluidos

**Organizador de Consumiveis**  
**Ref. 192762**  
**(420x335x62)**



Accesorios  
No incluidos

**Organizador de Consumiveis**  
**Ref. 192760**  
**(210x338x62)**



**Chave Roquete**  
**1/2" - Ref. 170720**  
**1/4" - Ref. 170700**  
**3/8" - Ref. 170710**



**Chave de Tubo c/corrente**  
**Ref. 111340**



**CADENA**  
**L: 50 cm**



**Bolsa de Ferramenta  
Ref. 196895**



**Bolsa de Ferramenta c/cinto  
Ref. 196894**



**Bolsa de Ferramenta  
Ref. 196895**



**Compasso Aço Pontas  
Ref.149002 – 150mm  
Ref.149003 – 200mm  
Ref.149004 – 250mm**



# GRACILMOR



**Lanterna 27 Leds**  
**Ref.190511**



**Lanterna 9 Leds**  
**Ref.170955**



**Serrote Pontas**  
**Ref. 144098**



**Pá de Alumínio**  
**Ref. 198621**



**Fita Métrica (5Mt x 25mm)**  
**Ref. 197310**  
**(cx12 unidades)**

## Martelos Utilitário



Nº 1



Nº 2



Nº 3



Nº 4



Nº 5

## SCREWDRIVERS · CHAVE DE FENDA · TOURNEVIS

REFS.

### 75×4

Comprimento Lenght	mm	75
Fenda Split	mm	4
Diâmetro Diameter	mm	∅ 4
Cabo Weight	mm	75×20
Peso Weight	gr	35



**1001**

### 100×5

Comprimento Lenght	mm	100
Fenda Split	mm	5
Diâmetro Diameter	mm	∅ 4
Cabo Handle	mm	75×20
Peso Weigt	gr	50



**1002**

### 125×6

Comprimento Lenght	mm	125
Fenda Split	mm	6
Diâmetro Diameter	mm	∅ 5
Cabo Handle	mm	82×22
Peso Weight	gr	50



**1003**

### 150×7

Comprimento Lenght	mm	150
Fenda Split	mm	7
Diâmetro Diameter	mm	∅ 6
Cabo Handle	mm	95×26
Peso Weight	gr	95



**1004**

## SCREWDRIVERS · CHAVE DE FENDA · TOURNEVIS

REFS.

### 175×8

Comprimento Length	mm	175
Fenda Split	mm	8
Diâmetro Diameter	mm	∅ 7
Cabo Handle	mm	95×26
Peso Weight	gr	115



1005

### 200×9

Comprimento Length	mm	200
Fenda Split	mm	9
Diâmetro Diameter	mm	∅ 8
Cabo Handle	mm	104×30
Peso Weight	gr	165



1006

### 250×10

Comprimento Length	mm	250
Fenda Split	mm	10
Diâmetro Diameter	mm	∅ 8
Cabo Handle	mm	104×30
Peso Weight	gr	185



1007

CARBURETTOR SCREWDRIVERS

CHAVE DE FENDA CARBURADOR

TOURNEVIS CARBURATEURS

### 30×6

Comprimento Length	mm	30
Fenda Split	mm	6
Diâmetro Diameter	mm	∅ 6
Cabo Handle	mm	55×30
Peso Weight	gr	40

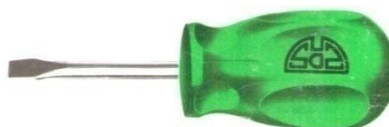

1008

## CROSS SLOTTED SCREWS · CHAVE DE ESTRELA · CRUCIFORME

REFS.

### N.º 0

Comprimento Length	mm	60
Estrela Cross	mm	-2
Diâmetro Diameter	mm	Ø 3
Cabo Handle	mm	75×20
Peso Weight	gr	30



2001

### N.º 1

Comprimento Length	mm	80
Estrela Cross	mm	2-3
Diâmetro Diameter	mm	Ø 5
Cabo Handle	mm	75×20
Peso Weight	gr	75



2002

### N.º 2

Comprimento Length	mm	100
Estrela Cross	mm	3-5,2
Diâmetro Diameter	mm	Ø 6
Cabo Handle	mm	83×23
Peso Weight	gr	65



2003

### N.º 3

Comprimento Length	mm	150
Estrela Cross	mm	5,2-7,2
Diâmetro Diameter	mm	Ø 8
Cabo Handle	mm	104×30
Peso Weight	gr	145



2004

## CROSS SLOTTED SCREWS · CHAVE DE ESTRELA · CRUCIFORME

REFS.

### N.º 4

Comprimento Lenght	mm	200
Estrela Cross	mm	7,2-12,7
Diâmetro Diameter	mm	Ø 10
Cabo Handle	mm	104×30
Peso Weight	gr	220



2005

CARBURETTOR SCREWDRIVERS

CHAVE DE ESTRELA CARBURADOR

TOURNEVIS CARBURATEURS

### N.º 2

Comprimento Lenght	mm	30
Estrela Cross	mm	2-3
Diâmetro Diameter	mm	Ø 6
Cabo Handle	mm	55×30
Peso Weight	gr	40

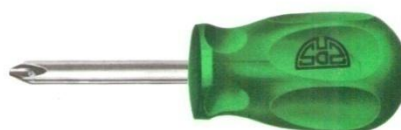

2006

CROSS SLOTTED SCREWS LENGTHY

CHAVE ESTRELA LONGA

CRUCIFORME LONG

### N.º 1

Comprimento Lenght	mm	150
Estrela Cross	mm	3-5,2
Diâmetro Diameter	mm	Ø 5
Cabo Handle	mm	75×20



2007

### N.º 2

Comprimento Lenght	mm	150/200
Estrela Cross	mm	5,2-7,2
Diâmetro Diameter	mm	Ø 6
Cabo Handle	mm	83×23
Peso Weight	gr	90



2008

## ELECTRICIAN SCREWDRIVERS · CHAVE DE FENDA ELÉCTRICA · TOURNEVIS POUR ÉLECTRICIENS

REFS.

### 75 / 100 × 3

Comprimento	mm	75/100
Lenght		
Fenda	mm	3
Split		
Diâmetro	mm	∅ 3
Cabo	mm	60 × 12
Handle		
Peso	gr	20
Weight		



1201

### 125/150- /200 × 4

Comprimento	mm	125/150/200
Lenght		
Fenda	mm	4
Split		
Diâmetro	mm	∅ 14
Diameter		
Cabo	mm	75 × 20
Handle		
Peso	gr	+ 65
Weight		



1202

### 150 × 5

Comprimento	mm	150
Lenght		
Fenda	mm	5
Split		
Diâmetro	mm	∅ 5
Diameter		
Cabo	mm	75 × 20
Handle		
Peso	gr	± 65
Weight		



1203

### 200 × 6

Comprimento	mm	200
Lenght		
Fenda	mm	6
Split		
Diâmetro	mm	∅ 6
Diameter		
Cabo	mm	83 × 23
Handle		
Peso	gr	80
Weight		



1204



## Jogos Chaves SDS 8 pcs



Ref. 4000

## Chaves Fenda SDS



- Fenda
- Philips
- Eletricista
- Cotos
- Furadores

## Busca Polos SDS

Ref. 1300 – 120cm

Ref. 1301 – 80cm



Ref. 1302 – 120cm



## Busca Polos WG 60 – 100mm



## Guia de Eletricista Nylon Branco



5M; 10M; 15M; 20M;  
25M; 30M



Betumadeira c/Borracha AST  
 AÇO / INOX  
 25mm; 40mm; 50mm; 65mm; 75mm;  
 100mm; 120mm



Colher Trolha  
 531 / 220 CC AST



Colher Trolha  
 532 / 220 CN AST

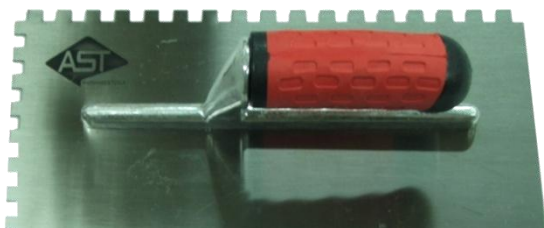

Talocha Dentada  
 AÇO / INOX (8x8)  
 280x130 AST (10x10)

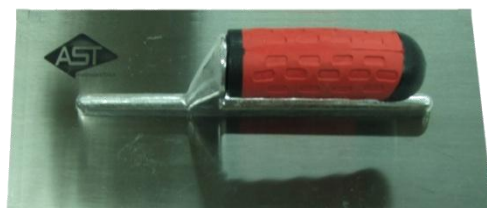

Talocha Lisa  
 AÇO / INOX  
 280x130 AST

Talocha Dentada  
 AÇO / INOX  
 480x130 AST



Talocha Lisa  
 AÇO / INOX  
 480x130 AST



(8x8)  
 (10x10)



# GRACILMOR

**Talocha Plástico**  
Nº1; Nº2; Nº3



**Talocha Plástico c/Bico**  
Nº 1



**Talocha Plástico c/Esjonja**  
Nº1



**Desempenadeira Plástica**  
Nº1 (3cm); Nº2 (5cm);  
Nº3 (7cm); Nº5 (9cm)



**Gamelas Plástica S/Asa**  
Nº3 – 35lt



**Gamelas Plástica S/Asa**  
Nº2



**Gamelas Plástica C/Asa**  
Nº1; Nº2



**Balde Plástico**  
10 Lts; 15Lts





**Hastes Completas**  
**Aluminio / Ferro Zincado**  
**150 – 400mm**



**Cruzetas para Azulejos**  
**2 – 8mm**



**Espátula Cabo Madeira**  
**Ref. 096**  
**10; 14; 18cm**



**Betumadeira Cabo Plástico**  
**40 – 120cm**



**Prumos Tipo Peso / Tipo Pião**



**Latão - Nº 3 ~ 8**  
**Ferro Latonado – Nº45 ~60**  
**Inox – Nº45 ~60**

**Prumo Cílico**  
**Ref. 264**



**300gr; 400gr; 500gr**



**Colher Trolha C/Madeira  
Cantos Cortados**  
Ref. 11230 – 22cm  
Ref. 11235 – 23cm



**Colher Trolha C/Bi-Matéria  
Cantos Cortados**  
Ref. 11232 – 22cm  
Ref. 11237 – 23cm



**Colher Trolha C/Madeira  
Cantos Normais**  
Ref. 10620 – 16cm  
Ref. 11120 – 22cm  
Ref. 11130 – 23cm



**Colher Trolha C/Bi-Matéria  
Cantos Normais**  
Ref. 10622 – 16cm  
Ref. 11122 – 22cm  
Ref. 11132 – 23cm



**Colher Trolha C/Madeira**  
Ref. 002 – 140mm  
Ref. 002 – 160mm



**Colher Estocador  
C/Madeira**  
Ref. 15-322 – 22cm



# GRACILMOR



**Espátula Cabo Madeira  
SVEDEN  
10; 14; 18cm**



**Colherim Bico  
C/Madeira  
Ref. 001 – 140mm**



**Martelo Cofrador C/Iman  
SVEDEN  
700gr - 24208**



**Malho Cabo Madeira  
SVEDEN  
23305 – 800gr  
23315 – 1000gr  
23325 – 1250gr  
23335 – 1500gr  
23345 – 2000gr**



**Malho S/cabo  
SVEDEN  
30200 – 3 Kg  
30210 – 4 Kg  
30220 – 5 KG  
30230 – 6 Kg**



# GRACILMOR

## SVEDEN



**TALOCHA ESPONJA**  
140 X 280  
Ref. 116750



**TALOCHA PLASTICO**  
130 X 280  
Ref. 15500



**TALOCHA BORRACHA**  
100 X 250  
Ref. 45265



**TALOCHA ESPONJA**  
15x26x4  
Ref. 45260



**VASSOURAO ESTRADA**  
C/CABO MADEIRA  
Ref. 53250 – 40CM  
Ref. 53260 – 60CM



**MAQUINA DE CARAPINHAR**  
Ref. 46000



**ESCOVA PARA**  
**MAQ DE CARAPINHAR**  
Ref. 46100



**Metros Plástico ABS**

**Ref. 025/01 – 1m**

**Ref. 026/02 – 2m**

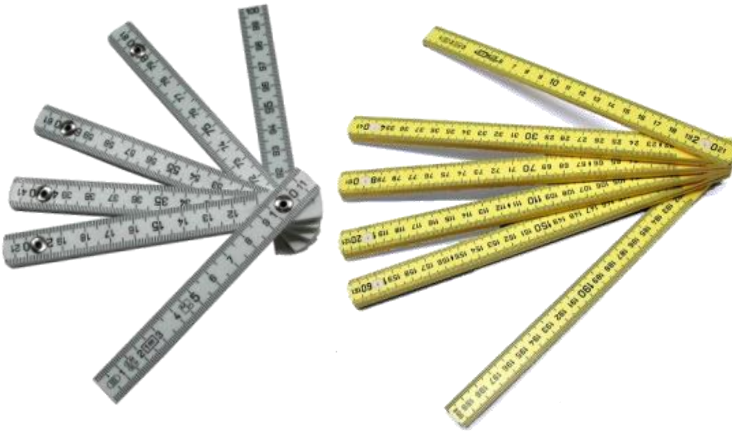

**Fita Métrica**  
**Ref. 011 – 50Mts**



**Suta de Aço**  
**Ref. 074/01**



**Esquadro de Pedreiro**  
**40x50cm**



**Esquadro Carpinteiro**  
**AST**



**10"; 12"; 14"**

**Esquadro de Carpinteiro**  
**Aluminio**  
**Ref. 078**



**40; 50; 60cm**

**Tarracha AST**  
**Ref. 2650 – 1/2" – 1.1/4"**



**Chave Lavatório**  
**Ref. AST 201**  
**11"**



**Esponja de Pedreiro**  
**17x10x5**  
**17x10x7**

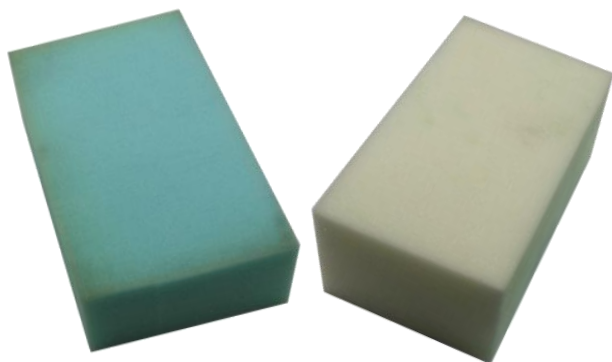

**Mola Desentupir Canos**  
**62835 – 3M x 6mm**  
**62858 – 5M x 8mm**  
**62860 – 10M x 8mm**



**Corta Vidros**  
**AST**



**Misturadores de Tinta**  
**AST**  
**400x60x8**  
**400x85x8**  
**600x100x10**





**Jogo de Machos e  
Cassonetes**  
40 Pcs  
Ref. 9180

**Jogo de Machos e  
Cassonetes**  
20 Pcs Ref. 9179



**Jogo de Machos  
BSW**  
Polgadas; Milimétrico

**Jogo de Bits  
WG**  
100 Pcs  
Ref. 10420



## Maçaricos Gás



- . AX073 - Ø 30
- . AX074 - Ø 45
- . AX062 - Ø 60

## Maçarico Soldador



. AX091

## Ferro de Soldas Tipo Pistola



. SE300GS

## Ferro de Soldar



- . SH040GS - 40W
- . SH060GS - 60W
- . SH080GS - 80W
- . SH100GS - 100W



# GRACILMOR

## Fogareiros a Gás

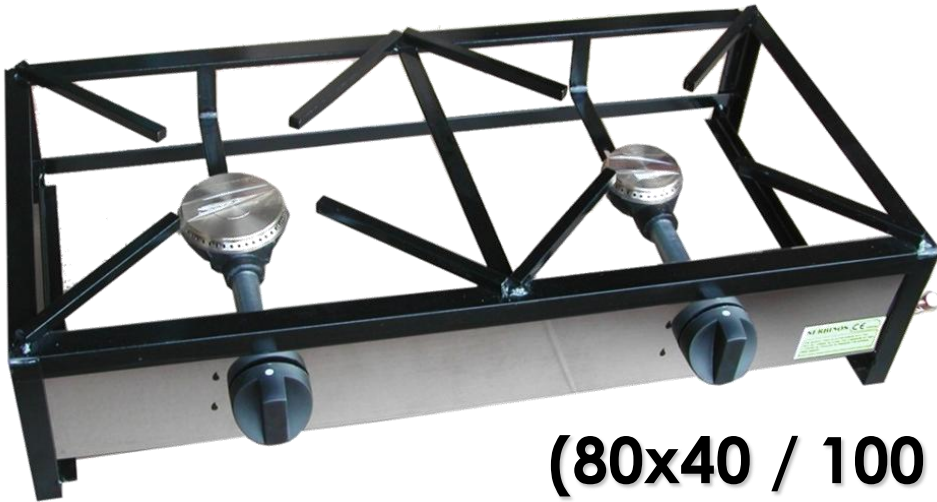

**(80x40 / 100 x 80)**



**(60x30 / 100 x 80)**



**Espalhadores**

**80 - 100**



**(30x30 / 100)**

**(40x40 / 100)**



**Grelha p/  
Fogareiro**

## • Máquina de Virar Ferro

- N°1 - 8mm
- N°2 - 12mm
- N°3 - 16mm



**Grampo de Cofragem  
80x80**

## • Prensa Carpinteiro

- 1.1/4"
- 1.1/8"

## Chave Virar Ferro

- Ref. 37800 - 6x8
- Ref. 37810 - 8x10
- Ref. 37820 - 10x12
- Ref. 37830 - 12x14



**Grampo de Aperto Rápido  
AST**



## Cavilhas de Cimenteiro

- M129 - Red / Qua
- 250mm





# GRACILMOR

**Pistola de Soprar  
C/ Manómetro**



**Pistola de Soprar**



**Pistola de Lavagem**



**Pistola de Pintura  
Copo Alto**



**Pistola de Pintura  
Copo Baixo**



**Mangueira (rolo 15m)**



**Kit Pintura 5 pcs**



**Mangueira 8mm  
(rolo 10m)**

**C/Tomada Universal  
+Engate Rápido**





**Bocas de Rega  
(Alumínio ou ferro fundido)**



**Boca Rega c/  
ligação**



**Boca Rega  
simples**



**Forja Completa  
c/ ventoinha**



Funil Plástico  
 Ref. 02 372  
 Compr: 205mm  
 Largura: 160mm



Funil Plástico  
 Ref. 02 674  
 Compr: 470mm  
 Largura: 160mm



Funil Plástico  
 Ref. 02 675  
 Compr: 160mm  
 + 300mm  
 Largura: 160mm



Funil Plástico  
 Ref. 02 366  
 Compr: 160mm  
 Largura: 200mm



Medidas Plástico  
 Ref. 07 501 – 1L  
 Ref. 07 502 – 2L  
 Ref. 07 505 – 5L

Medidas Plástico Graduadas  
 Ref. 07 062 – 1L  
 Ref. 07 063 – 2L  
 Ref. 07 065 – 5L





Bomba de  
Lubrificação  
Ref. 12 632



Bomba de  
Lubrificação c/pressão  
Ref. 18 072

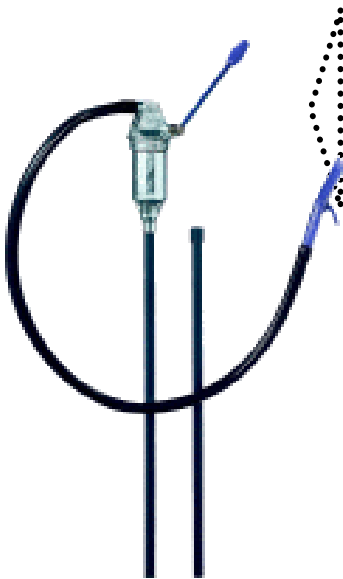

Bomba de trasfega  
Ref. 13 020

Seringa  
Ref. 12 902



Bomba de Trasfega  
Ref. 13 055



Massa de Lubrificação  
Ref.12 511



Massa de Lubrificação  
Grafite  
Ref.12 507





Almotolia Bico Flexível

- 125ml
- 175ml
- 250ml
- 350ml
- 500ml



Almotolia Bico Fixo

- 125ml
- 175ml
- 250ml
- 350ml
- 500ml



Bisnagas de Óleo  
60 ml – exp 25pcs  
Ref. 10 167



Grasseurs  
Cx 70pcs  
Ref. 16 092



Bicos para bomba de lubrificação ref. 12 731

Records flexível p/ bombas de lubrificação (8x300)  
Ref. 12 756



Records flexível p/ bombas de lubrificação (11x300)  
Ref. 12 755

Tubo para bomba de lubrificação  
ref. 12 735





## Jerrican para combustível



Ref. 21 141 – 5L



Ref. 21 143 – 10L



Ref. 21 147 – 20L



Metal – 20L  
Ref. 198875



Jerrican p/ água  
Ref. 21 163 – 10L  
Ref. 21 165 – 15L  
Ref. 21 167 – 20L



Jerrican Combinado  
( 5L + 2,5L )  
(5170901)



**Garibalde**  
**20100 - 1T x 3M**



**Macaco Hidráulico**  
**BAHCO**  
**2T**  
**4T**



**Cabos de Bateria AST**  
**200A; 400A**